

PLATINUM SMART-HEAT™ GAS

The Platinum Smart-Heat™ Gas heater series spreads heat and comfort evenly in all areas, with a soft and soothing red glow. Built with pure premium materials and designed with elegance, there is no compromise on performance, reliability and beauty.



500 SERIES



300 SERIES

SPECIFICATIONS

Reference the specification guide below to help you select the correct solution for your needs.

MODEL NUMBER	300 SERIES	500 SERIES
PRODUCT CODE	BH0110002-1 BH0110001-1	BH0110004-1 BH0110003-1
FUEL TYPE	LPG NG	LPG NG
COLOR	BLACK STAINLESS	BLACK STAINLESS
HEAT AREA	160FT ²	215FT ²
RATED CURRENT	110V/2A	110V/2A
MINIMUM FLOOR CLEARANCE	96"	96"
OUTPUT	23,600 BTU	39,800 BTU

MOUNTING OPTIONS

CEILING MOUNT	✓	✓
WALL MOUNT	✓	✓
RECESSED FLUSH MOUNT	-	-
CEILING POLE MOUNT	✓	✓
FREESTANDING	-	-

CONTROL OPTIONS

ON OFF	✓	✓
ON OFF PRODUCT CODE	BH3130010-1	BH3130010-1
DIMMER	-	-
MASTER REMOTE	-	-

Measurements displayed within this document are minimum requirements for installation. Bromic takes no responsibility for incorrect or non-compliant installations. All measurement in this document are displayed in inches.

DIMENSIONS

With a wide range of sizes available, find the ideal heater to suit your outdoor space.

FRONT PROFILE

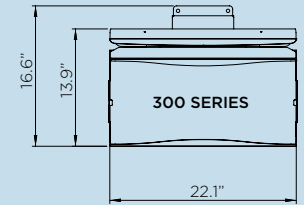
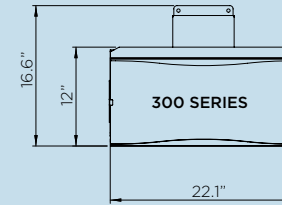
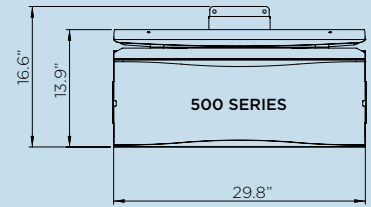
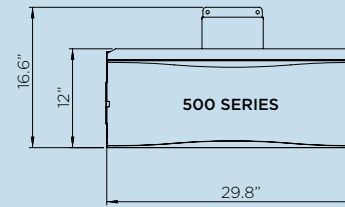

SIDE PROFILE

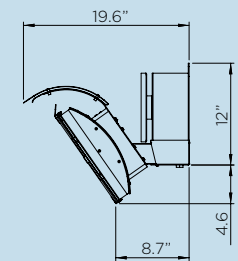
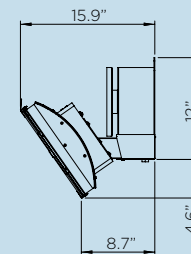

MOUNT OPTIONS

With a wide array of mounting options, Bromic offers solutions to compliment any décor and provide functionality for ambiance and comfort.

WALL MOUNT

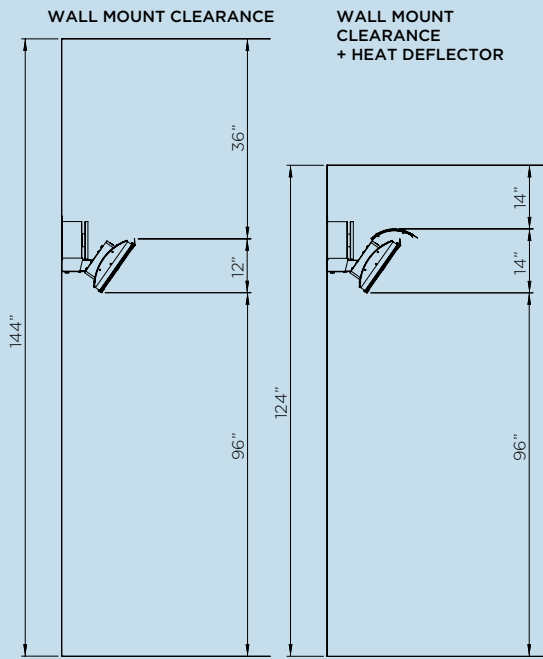

CEILING MOUNT

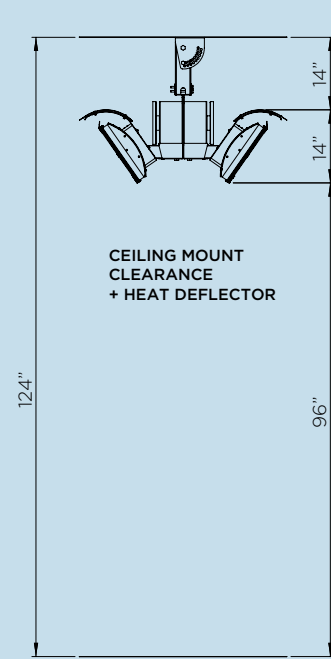

WALL BRACKET

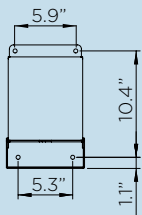

HEATING REACH

Creating ideal comfort levels, Bromic heaters offer a variety of heat distribution options to suit your outdoor heating needs.

500 SERIES

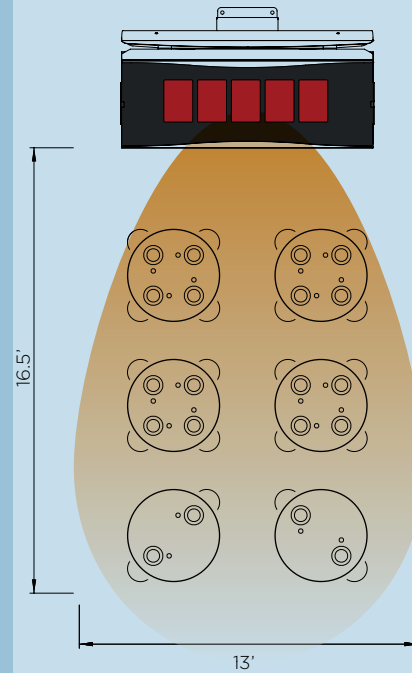

HEATING APPROXIMATELY 215FT²
39,800 BTU HEATING POWER

300 SERIES

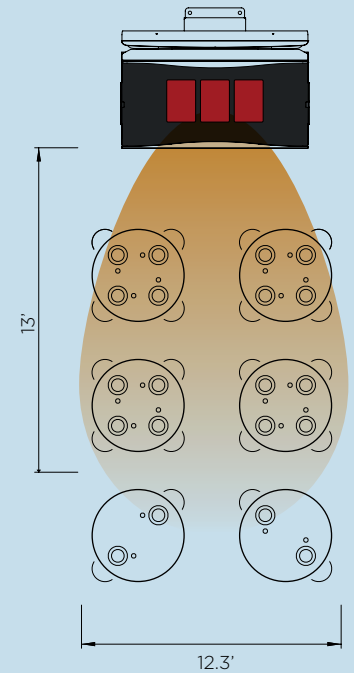

HEATING APPROXIMATELY 160FT²
23,600 BTU HEATING POWER

CONTROL OPTIONS



ON | OFF CONTROL



MASTER REMOTE



EXTEND YOUR COMFORT OUTDOORS
WITH THE SUPERIOR HEAT AND
AWARD-WINNING DESIGN OF OUR
SMART-HEAT™ OUTDOOR HEATERS.



PIVOT BRACKET
Allows for directional heat distribution

TOTAL MOUNTING FLEXIBILITY

PATENTED PERFORMANCE
Superior wind resistance

UNIQUE DESIGN
Ceramic fascia enables even heat distribution

PREMIUM CONSTRUCTION
High performing stainless steel for long lasting and durable use

BROMIC.COM/HEAT

ASIA PACIFIC | NORTH AMERICA | EUROPE

Bromic pursues a policy of continuing improvement in design and performance of its products. The right is therefore reserved to vary specifications without notice.
03.2021